

版次	变更摘要	日期	序号	品名	材质
			①	0.5后压卧式胶芯 (H1.0)	LCP UL94V-0 本色
			②	0.5后压卧式端子 (H1.0)	磷青铜/表面镀金
			③	0.5后压卧式后盖 (H1.0)	LCP UL94V-0 黑色
			④	0.5后压卧式焊片 (H1.0)	磷青铜/表面镀锡

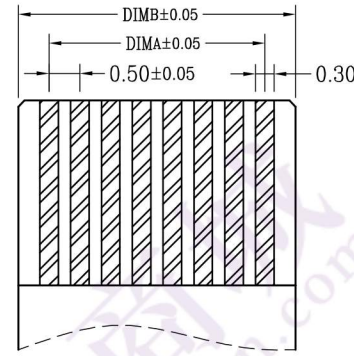
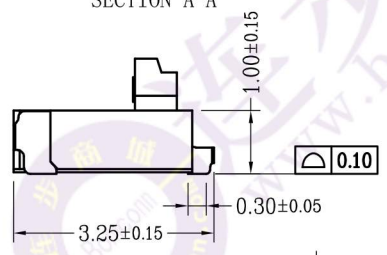
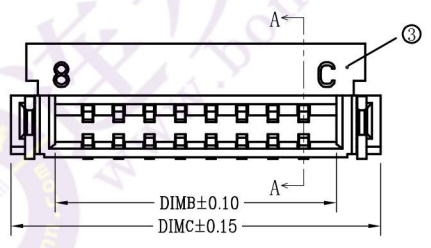
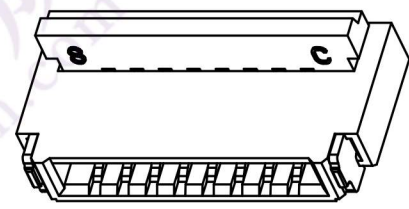
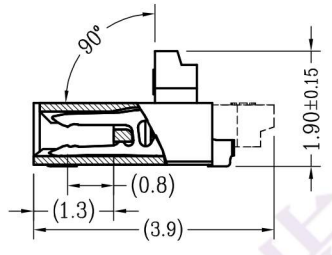
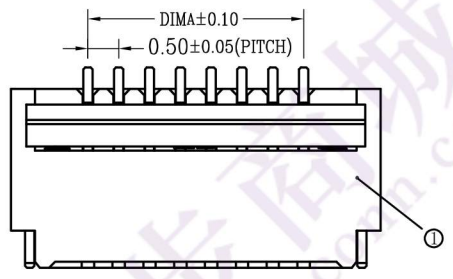

适用扁平线

CKT	DIMA	DIMB	DIMC	CKT	DIMA	DIMB	DIMC
4	1.50	2.56	4.00	23	11.00	12.06	13.50
5	2.00	3.06	4.50	24	11.50	12.56	14.00
6	2.50	3.56	5.00	25	12.00	13.06	14.50
7	3.00	4.06	5.50	26	12.50	13.56	15.00
8	3.50	4.56	6.00	27	13.00	14.06	15.50
9	4.00	5.06	6.50	28	13.50	14.56	16.00
10	4.50	5.56	7.00	29	14.00	15.06	16.50
11	5.00	6.06	7.50	30	14.50	15.56	17.00
12	5.50	6.56	8.00	31	15.00	16.06	17.50
13	6.00	7.06	8.50	32	15.50	16.56	18.00
14	6.50	7.56	9.00	33	16.00	17.06	18.50
15	7.00	8.06	9.50	34	16.50	17.56	19.00
16	7.50	8.56	10.00	35	17.00	18.06	19.50
17	8.00	9.06	10.50	36	17.50	18.56	20.00
18	8.50	9.56	11.00	37	18.00	19.06	20.50
19	9.00	10.06	11.50	38	18.50	19.56	21.00
20	9.50	10.56	12.00	39	19.00	20.06	21.50
21	10.00	11.06	12.50	40	19.50	20.56	22.00
22	10.50	11.56	13.00				

技术指标:

1. 塑件表面应光洁、无毛边、无明显收缩、缺陷、裂纹等现象。
2. 温度范围: -25°C~85°C.
3. 额定电压: 50V, AC/DC(等效).
4. 接触电阻: ≤0.03Ω.
5. 绝缘电阻: ≥500MΩ
6. 产品料号:

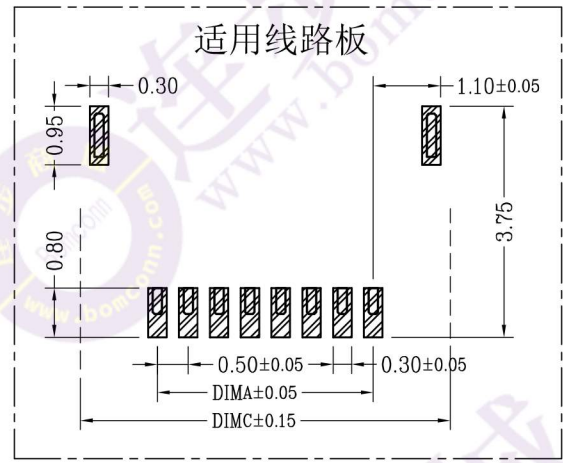

适用线路板

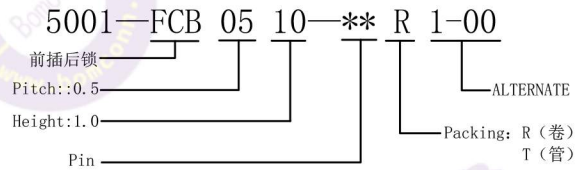

一般公差 (TOLERANCE)
 X ±.50 XX ±1.0
 X ±.20 XXX ±.05
 ANGLES ±1°

东莞市文章济美电子有限公司

品名 (TITLE) 0.5 Pitch后压卧式 (H=1.0)	制图 (DR) Anlan
料号 (DWG.NO) 5001-FCB0510-**-R1-00	校对 (CHKD) 王涛
比例 (SCALE) 1:1	审核 (APFD) 黄志明
单位 (UNITS) mm	张数 (SHEET) 1 OF 1
尺寸 (SIZE) A4	版本 (REV) A